

PRODUCT CATALOG

Revised March 15, 2010

SHIPPING:

- Standard ground shipping is included in the price for orders shipping within the continental U.S.
- A shipping surcharge will be applied to orders shipping outside the continental U.S.

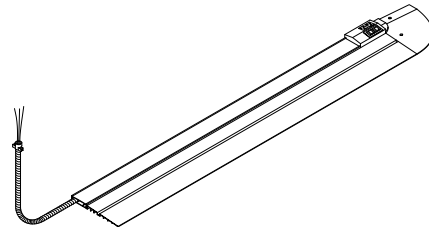
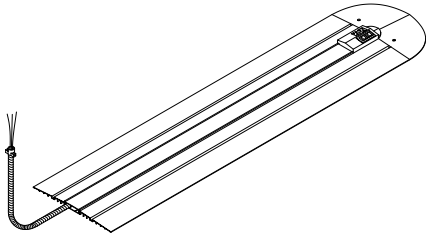

I Series

Provides a single-circuit 15A duplex receptacle and space for up to 4 voice/data ports. 24' power entry cable. Available in 48" and 96" lengths. 20A available.

INDA-048-KIT
INDA-096-KIT

Same as above, with black powder-coated raceway cap

INDA-048-KIT-BLCK
INDA-096-KIT-BLCK

Optional resilient rubber trim strip, available in five colors *

RES-048-KIT-XXXX
RES-096-KIT-XXXX

For window wall applications (ramp on one side only). Provides a single-circuit 15A duplex receptacle and space for up to 4 voice/data ports. 24' power entry cable. Available in 48" and 96" lengths. 20A available.

INDB-048-KIT
INDB-096-KIT

Same as above, with black powder-coated raceway cap

INDB-048-KIT-BLCK
INDB-096-KIT-BLCK

Optional resilient rubber trim strip, available in five colors *

RES-048-KIT-XXXX
RES-096-KIT-XXXX

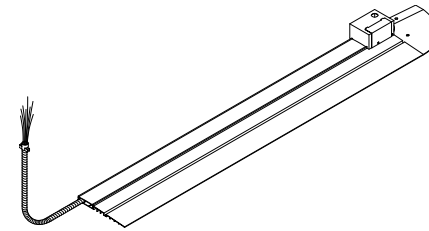
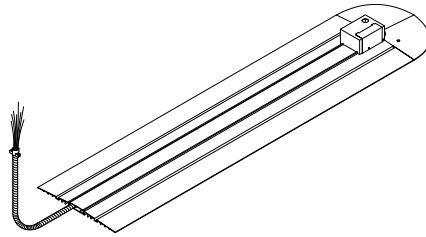

M Series

Provides 8-wire, 4-circuit power to a steel monument box for connecting to a furniture base feed. 24' power entry cable. Available in 48" and 96" lengths.

MODA-048-KIT
MODA-096-KIT

Same as above, with black powder-coated raceway cap

MODA-048-KIT-BLCK
MODA-096-KIT-BLCK

Optional resilient rubber trim strip, available in five colors *

RES-048-KIT-XXXX
RES-096-KIT-XXXX

For window wall applications (ramp on one side only). Provides 8-wire, 4-circuit power to a steel monument box for connecting to a furniture base feed. 24' power entry cable. Available in 48" and 96" lengths.

MODB-048-KIT
MODB-096-KIT

Same as above, with black powder-coated raceway cap

MODB-048-KIT-BLCK
MODB-096-KIT-BLCK

Optional resilient rubber trim strip, available in five colors *

RES-048-KIT-XXXX
RES-096-KIT-XXXX

I Series
perfect for conference tables, desks and podiums

M Series
ideal for furniture requiring 8-wire, 4-circuit power

ALL CONNECTRAC SYSTEMS UTILIZE THE SAME RACEWAY COMPONENTS

Customize any Connectrac system using corners, extensions, and accessories. All raceway components are easily trimmed to specific lengths in the field.

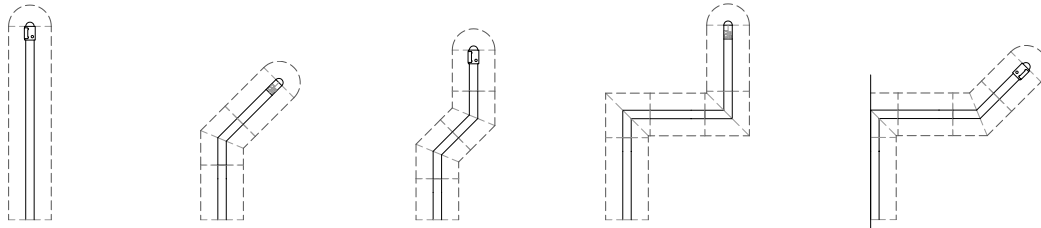

see all raceway components and accessories on the following pages

* See last page for rubber trim strip specification

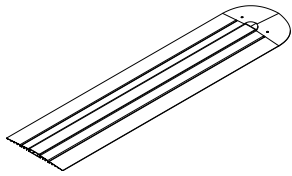

Raceway system without power components. Designed to end a run, available in 48" and 96" lengths.

NOPA-048-KIT
NOPA-096-KIT

Same as above, with black powder-coated raceway cap

NOPA-048-KIT-BLCK
NOPA-096-KIT-BLCK

Optional resilient rubber trim strip, available in five colors *

RES-048-KIT-XXXX
RES-096-KIT-XXXX

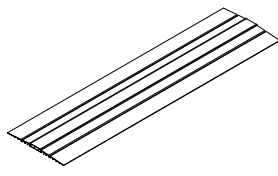

Raceway system without power components. Designed to extend a run, available in 48" and 96" lengths.

EXTN-048-KIT
EXTN-096-KIT

Same as above, with black powder-coated raceway cap

EXTN-048-KIT-BLCK
EXTN-096-KIT-BLCK

Optional resilient rubber trim strip, available in five colors *

RES-048-KIT-XXXX
RES-096-KIT-XXXX

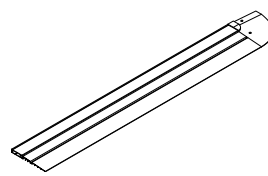

Raceway system without power components for window wall applications (ramp on one side only). Designed to end a run, available in 48" and 96" lengths.

NOPB-048-KIT
NOPB-096-KIT

Same as above, with black powder-coated raceway cap

NOPB-048-KIT-BLCK
NOPB-096-KIT-BLCK

Optional resilient rubber trim strip, available in five colors *

RES-048-KIT-XXXX
RES-096-KIT-XXXX

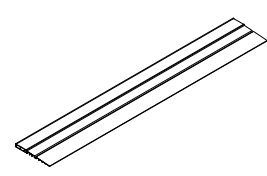

Raceway system without power components for window wall applications (ramp on one side only). Designed to extend a run, available in 48" and 96" lengths.

EXTB-048-KIT
EXTB-096-KIT

Same as above, with black powder-coated raceway cap

EXTB-048-KIT-BLCK
EXTB-096-KIT-BLCK

Optional resilient rubber trim strip, available in five colors *

RES-048-KIT-XXXX
RES-096-KIT-XXXX

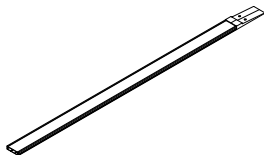

Extra raceway channel. Available in 48" and 96" lengths. Can be ganged together to create multiple, separated channels to increase capacity.

EXCL-048-KIT
EXCL-096-KIT

Same as above, with black powder-coated raceway cap

EXCL-048-KIT-BLCK
EXCL-096-KIT-BLCK

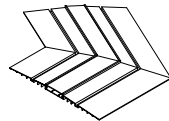

Pre-cut corner kits, 45° / 90°.

CRNR-045-KIT
CRNR-090-KIT

Same as above, with black powder-coated raceway cap

CRNR-045-KIT-BLCK
CRNR-090-KIT-BLCK

available in custom angles †

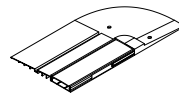

Side entry kit. Allows cables to enter the raceway from the side instead of the end.

SIDE ENTRY-KIT

Same as above, with black powder-coated raceway cap

SIDE ENTRY-KIT-BLCK

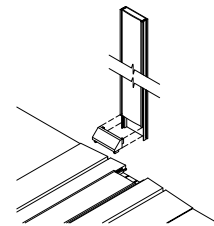

Vertical raceway for use in surface-mounted wall conditions. Includes transition from floor raceway to vertical raceway. 12' length.

WALL-144-KIT

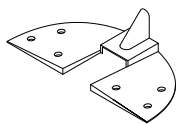

Base transition kit, allows cables to leave raceway and enter a "mouse hole" in side of hollow table base.

BASE-001-KIT

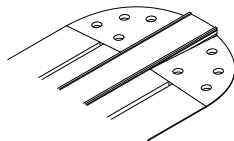

Alternate style end ramps, allows cables to exit the raceway at the end rather than the top.

BASE-002-KIT

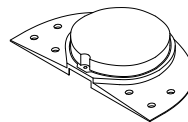

Dome cover kit. Used to cover poke-thru device assemblies.

DOME-001-KIT

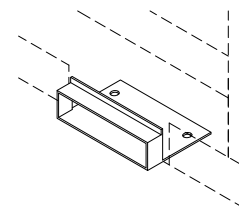

Steel rough-in box. For optional use in new wall construction. Installed prior to gypsum board, it provides an opening for cables to pass through.

RIB-000

* See last page for rubber trim strip specification

† Special order items require a 10-15 day lead time

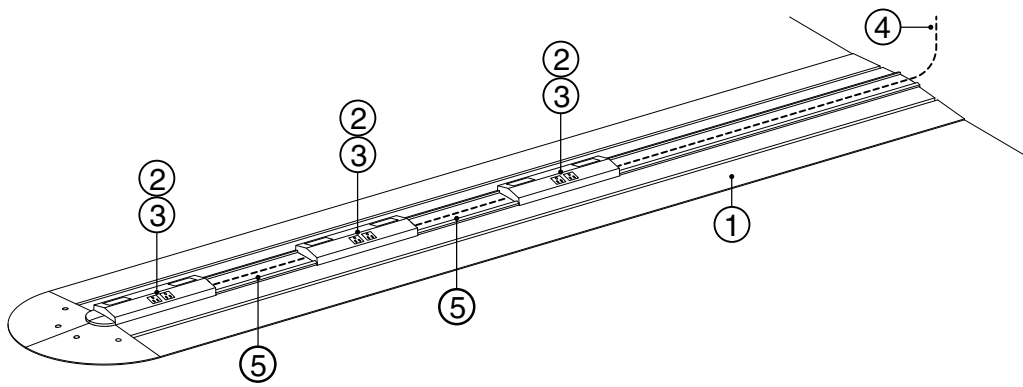

U Series

The U Series is a highly customizable and flexible connectivity solution. Any number of receptacles can be specified in any configuration of Connectrac raceway components. The diagram above shows the components that go into a complete U Series system, and must be specified individually.

1 Raceway Components

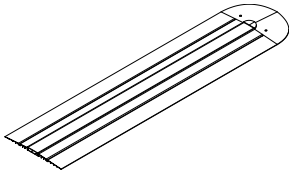

Raceway system without power components. Designed to end a run, available in 48" and 96" lengths.

NOPA-048-KIT
NOPA-096-KIT

Same as above, with black powder-coated raceway cap

NOPA-048-KIT-BLCK
NOPA-096-KIT-BLCK

Optional resilient rubber trim strip, available in five colors *

RES-048-KIT-XXXX
RES-096-KIT-XXXX

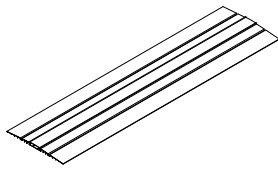

Raceway system without power components. Designed to extend a run, available in 48" and 96" lengths.

EXTN-048-KIT
EXTN-096-KIT

Same as above, with black powder-coated raceway cap

EXTN-048-KIT-BLCK
EXTN-096-KIT-BLCK

Optional resilient rubber trim strip, available in five colors *

RES-048-KIT-XXXX
RES-096-KIT-XXXX

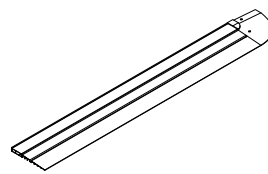

Raceway system without power components for window wall applications (ramp on one side only). Designed to end a run, available in 48" and 96" lengths.

NOPB-048-KIT
NOPB-096-KIT

Same as above, with black powder-coated raceway cap

NOPB-048-KIT-BLCK
NOPB-096-KIT-BLCK

Optional resilient rubber trim strip, available in five colors *

RES-048-KIT-XXXX
RES-096-KIT-XXXX

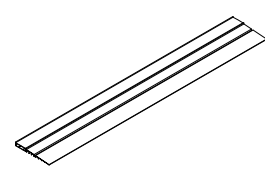

Raceway system without power components for window wall applications (ramp on one side only). Designed to extend a run, available in 48" and 96" lengths.

EXTB-048-KIT
EXTB-096-KIT

Same as above, with black powder-coated raceway cap

EXTB-048-KIT-BLCK
EXTB-096-KIT-BLCK

Optional resilient rubber trim strip, available in five colors *

RES-048-KIT-XXXX
RES-096-KIT-XXXX

2 3 4 5 Electrical Components

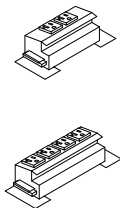

Duplex receptacle, 15 / 20 amp.

RECM-XXX
RECM-XXX-20A

Quad receptacle, 15 / 20 amp

RECM-XXX-QD
RECM-XXX-QD-20A

for detailed receptacle specification see the next page

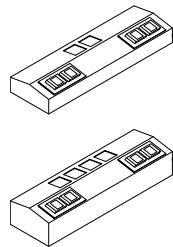

Duplex power / data receptacle cover with voice / data adapter plate kit.

COVM-000-KIT

Quad power / data receptacle cover with voice / data adapter plate kit.

COVM-400-KIT

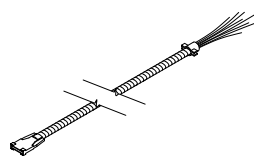

Power entry cable, 8-wire / 4-circuit, 24' length

MODC-288

Power entry cable, 6' length

MODC-072

available in custom lengths[†]

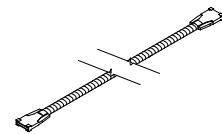

Quick-connect jumper cable, 8-wire / 4-circuit, available in 6" increments.

for detailed jumper specification see the next page

* See last page for rubber trim strip specification

† Special order items require a 10-15 day lead time

U Series Receptacle Information

Part Number	Description
RECM-(001/002/003)	Duplex receptacle (both outlets on same circuit); shared neutral and ground; 001 = circuit 1, 002 = circuit 2, 003 = circuit 003; 15A, NEMA 5-15R
RECM-004	Duplex receptacle (both outlets on same circuit); dedicated neutral and ground; circuit 4; 15A, NEMA 5-15R
RECM-(001/002/003)-20A	Duplex receptacle (both outlets on same circuit); shared neutral and ground; 001 = circuit 1, 002 = circuit 2, 003 = circuit 003; 20A, NEMA 5-20R
RECM-004-20A	Duplex receptacle (both outlets on same circuit); dedicated neutral and ground; circuit 4; 20A, NEMA 5-20R
RECM-(001/002/003)-QD	Quad receptacle; 3 receptacles (on same circuit) share neutral and ground. (001 = circuit 1, 002 = circuit 2, 003 = circuit 003), and fourth receptacle (circuit 4) has dedicated neutral and ground. 15A, NEMA 5-15R
RECM-(001/002/003)-QD-20A (SPECIAL ORDER †)	Quad receptacle; 3 receptacles (on same circuit) share neutral and ground. (001 = circuit 1, 002 = circuit 2, 003 = circuit 003), and fourth receptacle (circuit 4) has dedicated neutral and ground. 20A, NEMA 5-20R

U Series Jumper Information

Below is a listing of all standard 15A 8-wire / 4-circuit jumper cables. Custom lengths may be ordered by specifying **JUMP-XXX-SPECIAL**, where 'XXX' is the on-center receptacle dimension in inches.

JUMP-024	JUMP-060
JUMP-030	JUMP-066
JUMP-036	JUMP-072
JUMP-042	JUMP-084
JUMP-048	JUMP-096
JUMP-054	

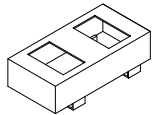

Communications kit. Steel device box allows for extra voice/data port capacity. Provides (2) standard modular-furniture sized knockouts.

COMM-000-KIT

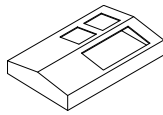

I Series receptacle cover.
COVA-000

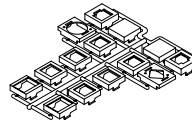

Voice / data adapter plate kit. Provides (2) voice or data ports per knockout. Manufacturer-specific adapter plate must be provided to achieve (4) voice or data ports per knockout.

BEZL-000

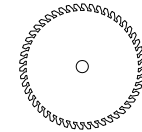

Non-ferrous metal-cutting saw blade for cutting aluminum and PVC raceway components, 10" diameter.

SAWB-000

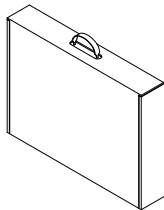

Connectrac demonstration kit. Visit www.connectrac.com for more information.

DEMO-KIT-000

* **Optional Resilient Rubber Cap Insert**, available in 48" and 96" lengths.

RES-048-KIT-XXXX
RES-096-KIT-XXXX

Replace 'XXXX' with one of the following color options:

BLCK	Roppe® "Black" No. 100
BKBN	Roppe® "Black-Brown" No. 193
JAVA	Roppe® "Java" No. 619
NAVY	Roppe® "Deep Navy" No. 139
LUNR	Roppe® "Lunar Dust" No. 114

† Special order items require a 10-15 day lead time